

SAS908WHB-3-RF/B WIRELESS THERMOSTAT

Installation and operation instructions

908WHB-3-RF/B can replace most common residential thermostat and is designed to be used with electric, gas or oil heating control system or cooling system.

Unlike ordinary single unit design thermostat, this unit is a new type of thermostat separating the thermostat function into two units. Receiver SAS2000WHB-Re and Control Centre SAS908WHB-3-Tr. The Receiver serves for wiring connections and heat/cool on/off control. The Control Centre serves as user interface and temperature sensing/control. User can put the control Centre nearby and can read/control the temperature of the living area while the Receiver sits besides the heating or cooling system. The two units are linked by RF.

SPECIFICATION:

Power source	Control Centre 2 AA batteries Receiver 230VAC 50HZ
Frequency band.....	433 MHZ
Relay contact	230VAC 16A
Room temperature setting range.....	5°C to 35°C (41°F to 95°F)
Accuracy.....	±1°F or ±0.5°C
Dimensions.....	Control Centre 115mm×90mm×28mm Receiver 88mm×88mm×40
Color.....	White

FEATURE:

- Can be placed anywhere in the home to detect and control the temperature of an area of the user's choice. Not limited by power control wiring locations.
- Link with the Receiver via RF. Control distance 100M open site.
- Large LCD display
- The screen displays the set temperature and the room temperature also time simultaneously
- Permanent user setting and program setting retention during power loss
- Optional temperature display of Celsius or Fahrenheit scale
- Both Vacation mode and hold duration mode available for comfort and energy saving
- Separate 5-day (weekday) and 1-day/1-day (Saturday/Sunday) programming with four separate time/temperature periods per day
- Display temperature recalibrates
- Low battery indication
- Anti-freeze protection
- Pump protection available

IMPORTANT SAFETY INFORMATION:

- Always turn off power at the main power source by unscrewing fuse or switching circuit breaker to the off position before installing, removing, cleaning, or servicing this thermostat.
- Read all of the information in this manual before installing this thermostat.
- Only a professional contractor should install this thermostat.

- All wiring must conform to local and national building and electrical codes and ordinances.
- This thermostat has a removable fuse to protect the system from damage. If system is not operating properly, check wiring and replace fuse if necessary.
- Use this thermostat only as described in this manual.

RF ADDRESS CODE SETTING

If there is another user nearby, e.g. in the next house, your receiver may be fault triggered by their transmitter. You may select a different RF address code to prevent this. Receivers can only respond to RF coding with the same address code setting as its own address code. If you want to change the RF address to avoid miss-triggered by other user, you should adjust address code of both Receiver and the Control Centre.

1. To adjust address code of Receiver, simply push up one or more of the 8 dip switch levers.
2. To adjust address code of Control Centre, open the housing of the Control Center. See install the Control Centre. According to the modified address code of Receiver, adjust the address code of Control Centre to the same address of Receiver by pushing up the 8 dip switch levers.

Caution:

1. Address code of Control Centre must be the same as address code of Receiver.
2. Disconnect AC power and remove batteries prior to adjusting address code.

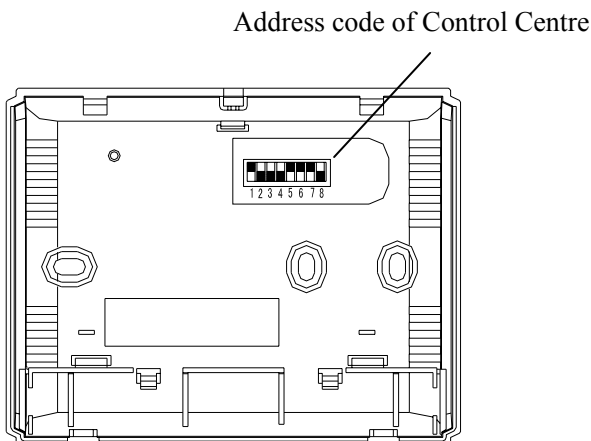

Figure 1

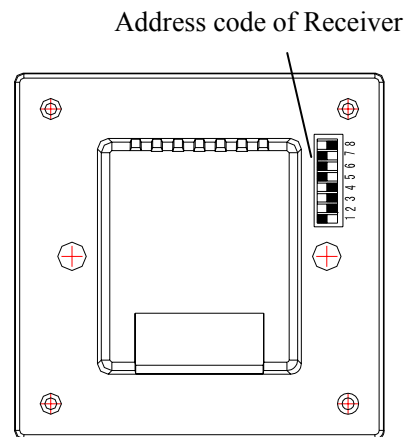

Figure 2

MOUNTING THE RECEIVER

Mounting the Receiver onto the optional wall box (See Figure 3)

1. Remove the front cover of the Receiver
2. Mark the holes position for the wall box
3. Drill two holes and insert the plastic anchors carefully into the holes until they are flush with the wall.
4. Push the wires into the wall box and fasten the wall box onto the wall
5. Connect the wires-See wiring diagram
6. Push on the wires in the wall box.
7. Securely fasten the Receiver to the wall box with the two screws.
8. Replace the front cover and installation is completed

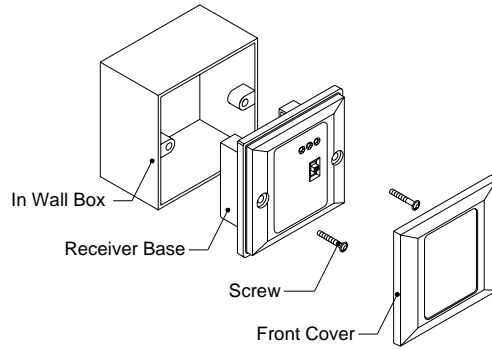

Figure 3

WIRING DIAGRAM

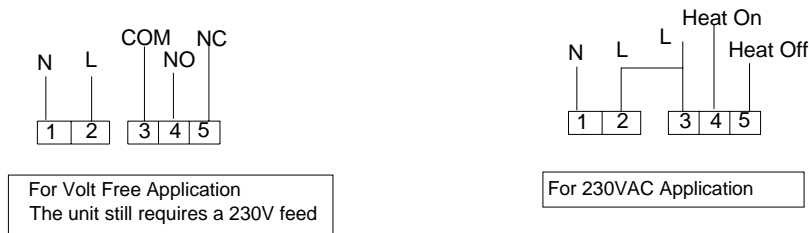

Figure 4

INSTALL THE CONTROL CENTRE

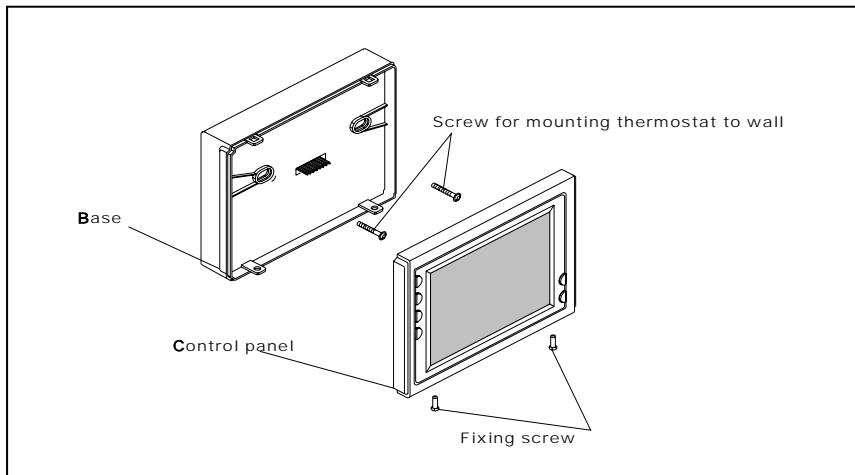

Figure 5

1. Remove 2 screws from the bottom of thermostat. (See Figure 5) Gently pull the control panel straight off the base. Forcing or prying on the thermostat will cause damage to the unit.
2. Push power base into wall.
3. Using two mounting screws mount the power base to the wall. Place a level against bottom of base, adjust until level, and then tighten screws. (Leveling is for appearance only and will not affect thermostat operation.)
4. Replace control panel on the power base and fix power base and control panel by removed two screws in item 1.

KEYBOARD, DISPLAY AND SWITCH DESCRIPTION OF CONTROL CENTRE

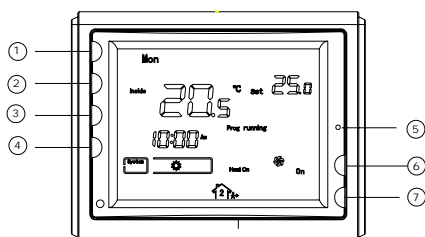

Figure 6

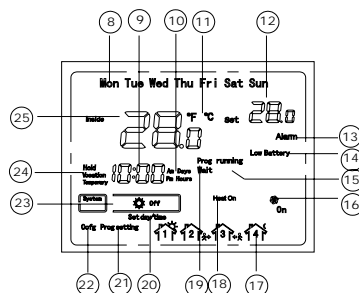





Figure 7

- ① Power on/ anti-freezing /off button
- ② Time setting button
- ③ Program setting button
- ④ Program run confirmation button
- ⑤ Reset button
- ⑥ Raise Temperature setting button
- ⑦ Lower Temperature setting button
- ⑧ Shows current day or days being programmed.
- ⑨ Shows current time or times being programmed
- ⑩ Am:: Morning , Pm:: Afternoon Days: Nr of days, Hours: Nr of hours
- Shows temperature display in °C or °F
- Setting temperature
- Indicates a malfunction with the system.
- Low battery indicator
- Shows when thermostat is in the programming mode.
- Shows when thermostat is in the pump protection mode
-  time to get up,
  time to go out
  time to come back home
-  time to go to bed
- Shows the thermostat is calling for heat
- Wait icon
- Set day/time: Shows current day and time being displayed
- ⑪ Prog setting: Shows when the thermostat is in program setting mode.
- ⑫ Cofg: Shows when the thermostat is in the configuration mode
- ⑬ Shows current system mode
- ⑭ Hold: Shows when thermostat is in the holding temperature mode
- Vacation: Shows when thermostat is in the vacation mode.
- ⑮ Shows current room temperature.

SWITCH AND LED DESCRIPTION OF RECEIVER

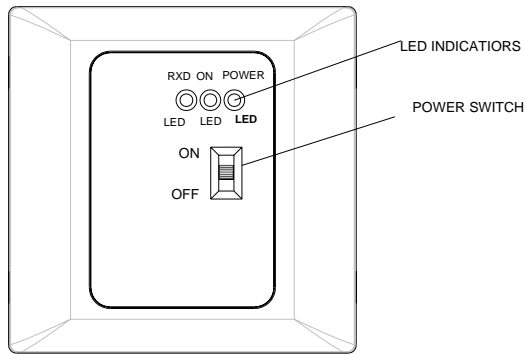

Figure 8

POWER SWITCH: When there is no demand to turn on the heating/cooling device, it is recommended to turn the power switch to the off position.

LED INDICATOR:

1. Red LED turns on as long as there is power to the unit
2. Green LED turns on as long as the heating/cooling device is energized.
3. Yellow LED flashes as long as there are any signals received from the Control Centre.

CHECK THERMOSTAT OPERATION

The unit will be controlled via air sensor in the Control Centre and the Control Centre will determine to activate/deactivate heating system by comparing set temperature with room temperature. Press ▲ to adjust Control Centre setting above room temperature 1°C in fast heating mode or 3°C in slow heating mode, See configuration menu item 5. The Control Centre will emit signals to the Receiver asking to turn on the heating/cooling device. Yellow LED on the Receiver flashes means Receiver has received the signals. Green LED turns on means heating/cooling device are energized. Press ▼ to adjust Control Centre setting below room temperature. The Control Centre will emit signals to the Receiver asking to turn off the heating/cooling device. Yellow LED on the Receiver flashes means Receiver has received the signals. Green LED turns off means heating/cooling device are deactivated.

OPERATION

1. Configuration Menu

The configuration menu allows you to set certain thermostat operating characteristics to your system or personal requirements. Shortly press button ① to make sure the thermostat is in anti-freeze mode. Hold button ③ for 3 seconds to enter the configuration menu. The display will show the first item in the configuration menu. Press button ③ to shift to the next menu item. Use ▲、▼ to select. To exit the menu, press button ① revert to the anti-freeze mode. Press button ④ revert to the program operation. If no buttons are pressed within 20 second the thermostat will exit the menu. To revert to factory default setting, push ▲、▼ button in a same time for 3 seconds. Display will show “DEF” blinking 3 times and return to Menu item 1 indicates all the configuration setting has reverted to factory default setting.

Step	Press buttons	Displayed (factory default)	Press▲、▼to select	Descriptions
1	③	01 (0)	-3 --- +3	Select temperature display adjustment higher or lower
2	③	02 (35°C)	18°C(64°F)—35°C(95°F)	Select maximum setting temperature for heating
3	③	03 (5°C)	5°C(41°F)—20°C(68°F)	Select minimum setting temperature limitation
4	③	04 (°C)	°C/°F	Select temperature display to°C or °F
5	③	05 (FA)	FA/SL	Select fast heating or slow heating
6	③	06 (PP)	PP/OO	Select pump protection PP Cancel pump protection OO
7	Press button ④ revert to the program operation			

1) Select temperature recalibrates Adjustment 3 LO to 3 HI –

You can adjust the room temperature display up to 3 higher or lower. Your thermostat was accurately calibrated at the factory but you have the option to change the display temperature to match your previous thermostat. The current or adjusted room temperature will be displayed on the right side of the display.

2) Select maximum temperature set point

This feature provides a maximum set point temperature f. The default setting is 35°C (95°F), It can be changed between 18°C (64°F) to 35°C (95°F)

3) Select minimum temperature set point.

This feature provides a minimum set point temperature. The default setting is 5°C (41°F), It can be changed between 5°C (41°F) to 20°C (68°F)

4) Select °F or °C readout.

Changes the display readout to Centigrade or Fahrenheit as required

5) Select fast heating or slow heating

Select FA to start heating immediately when the set point is 1°C above the room temperature. Select SL to start heating only when the set point is 3 °C above the room temperature.

6) Select pump protection mode

For hot water installations, it is recommended to activate the pump at least 15 second every 24 hours in order to avoid any seizing. Select PP will activate pump protection mode. Select OO will cancel the function. When thermostat is activating the pump, ③ in the display will blink.

2. Manual Operation

1) On/Anti-freezing mode

You can press power button ① to activate the anti-freezing mode. The unit only displays Clock time, Weekday and Room temperature. The default set temperature for anti-freezing mode is 5°C. During anti-freezing mode, if room temperature is below 5°C, the unit will activate the heating system till room temperature reaches 9°C. For hot water installations, if PP had been selected (See Configuration menu item 6), the unit will activate the pump at least 15 seconds every 24 hours in order to avoid any seizing. Press power button ① again will terminate the anti-freezing mode and return to normal operation mode.

2) Program operation and Hold temperature operation

Momentarily press ④ shift between program operation and hold temperature operation. **Prog running** shows when thermostat is in program operation. Thermostat controls the heating system by presetting program. See **Planning your program** section. **Hold** shows when thermostat is in hold temperature operation. The thermostat will hold the room temperature at the selected setting

3) Temperature override

During program operation, Press ▲、▼ until the temperature you want is displayed. The thermostat will override the current programming and keep the room temperature at the selected temperature until the next program period begins. Then the thermostat will automatically revert to the program.

4) Vacation Temperature hold

Continue pressing button ③ over 3 seconds until display will show Vacation indicates you have now entered into vacation hold. Use time key ② to select the number of the days (from 1 to 99 days) during your vacation., you can use ▲、▼ to adjust the temperature during your holiday. Push button ④ to revert to program operation. .

5) Reset operation

If the display is abnormal, press the Reset button by using a fine probe such as a straightened paper

clip to gently push the Rest button. This will reset the thermostat.

3. Set current day and time

- 1) Press ② button. The display will show the hour flashing.
- 2) Press and hold either ▲、▼ until you reach the correct hour and AM/PM designation.(AM begins at night, PM begins at noon)
- 3) Press ② button once again. The display will only show minutes flashing
- 4) Press and hold either ▲、▼ until you reach the correct minutes
- 5) Press ② button once again. The display will show the day of the week flashing.
- 6) Press ▲、▼ until you reach the correct day of the week

Press button ④ once. The display will show the correct day of the week and the time. If no keys are pressed within 20 seconds, the thermostat will revert to program operation.

4. Planning your program





Look at the factory preprogrammed times and temperatures shown in the sample schedule. If this program will suit your needs, simply press the ④ button to begin running the factory preset program.

If you want to change the preprogrammed time and temperature, follow these steps.

Determine the times period and temperature for your program. You must program four periods for each day. You can choose heating temperature and start time independently. (for example, you may select 5:00 AM and 70°F as the weekday 1st period heating start time and temperature and also choose 7:00 AM and 76°F and the weekday 1st period cooling start time and temperature)

Use the table to plan your program time periods and the temperatures you want during each period. Fill in the complete table to have a record of your program

Heating Schedule Plan (Factory default program setting)

Period		Weekdays (5 day)		Saturday		Sunday	
		Start time	Temperature	Start time	Temperature	Start time	Temperature
Heat		6:00 AM	21°C	6:00 AM	21°C	6:00 AM	21°C
		8:00 AM	16.5°C	8:00 AM	16.5°C	8:00 AM	16.5°C
		5:00 PM	21°C	5:00 PM	21°C	5:00 PM	21°C
		10:00 PM	16.5°C	10:00 PM	16.5°C	10:00 PM	16.5°C

Enter Heating Program

- 1). Press ③ once. **PRGM SETTING** will display. “MO TU WE TH FR” (indicating weekday program) will appear in the display. Also be displayed are the currently programmed start times for the

1st heating period and the currently programmed temperature (flashing), icon  indicates 1st program period (Get up) setting.

- 2). Press ② to set the programmed time or programmed temperature, Press ② once (the programmed temperature will flash), Press ▲、▼ to change the displayed temperature to your selected temperature for the 1st heating program period.

-
- 3). Press ② once (the programmed time will flash). Press ▲、▼ until your selected time appears. The time will change in 15-minute increments. When your selected time is displayed, press TIME again to return to the change temperature mode.
 - 4). Press ③ once, icon  2nd program period (Go out) display, the currently programmed start time and set point temperature for the 2nd heating program period will appear
 - 5). Repeat steps 3 and 4 to select the start time and heating temperature for the 2nd heating program period.
 - 6). Repeat steps 3 through 5 for the 3rd and 4th heating program periods
 - 7). Press ③ once. "SA" (indicating Saturday program) will appear in the display, along with the start time for the 1st heating period and the currently programmed temperature.
 - 8). Repeat steps 3 through 7 to complete Saturday heating programming.
 - 9). Press ③ once to change to SU (Sunday) heating programming and repeat steps 3 through 7 to complete Sunday programming.
 - 10). When you have completed entering your heating program, press ④.

REVERT TO FACTORY DEFAULT PROGRAM SETTING

Press ③ button enter into program setting. Press ▲、▼ at the same time for 3 seconds. Display will show DEF blinking for 3 times and back to program setting. Press the ④ button to begin running the factory preset program. If no keys are pressed within 20 sec, the thermostat will revert to program operation.

CHECK YOUR PROGRAMMING

Follow these steps to check your thermostat programming one final time before beginning thermostat operation.

1. Press button ③ to view the 1st weekday heating period time and temperature. Each time you press button ③, the next heating period time and temperature will be displayed in sequence for weekday, then Saturday and Sunday program periods (you may change any time or temperature during this procedure).

Press button ④ to begin program operation.

CUSTOMER ASSISTANCE

After reading this guide, if you have any question about the operation of your thermostat, please contact your supplier